

Collect Them All!

(Sold separately)



Raptor Racers Track Set



Stunt Flight Track Set

Build A Mega Track!



DISCOVER MORE SETS

For USA



[www.vtechkids.com/
turboedgeriders](http://www.vtechkids.com/turboedgeriders)

For Canada



[www.vtechkids.ca/en/
turboedgeriders](http://www.vtechkids.ca/en/turboedgeriders)

















Rally Track Set



5639

COMPONENTS

 x1	T-01  x2	T-02  x1	T-03  x1
C-01  x2	C-02  x1	C-03  x1	C-04  x2
C-05  x1	C-06  x3	C-07  x10	C-08  x10
C-09  x2	C-10  x4	L-01  x1	

P-01  P-02  P-03 

P-04  P-05  P-06 

P-07  P-08 

P-09  P-10  P-11 



Ruler

INITIAL ASSEMBLY

GETTING STARTED

COLOR THE TRACK

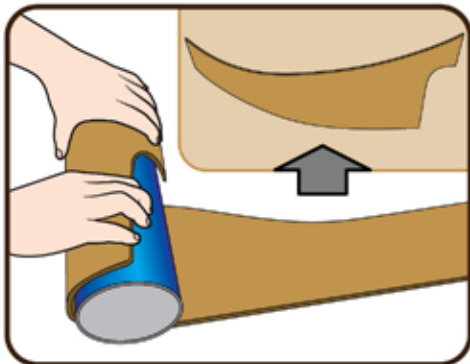
Color the **cardboard**. Roll **T-01**, **T-02** and **T-03** up with a can to make smooth curves.



ASSEMBLY INSTRUCTIONS

With the **Turbo Edge Riders™ Rally Track Set**, safety comes first. Adult assembly required. For your child's safety, do not let them play with this toy until the initial assembly steps are completed.

Stick the rubber label under all the stands.

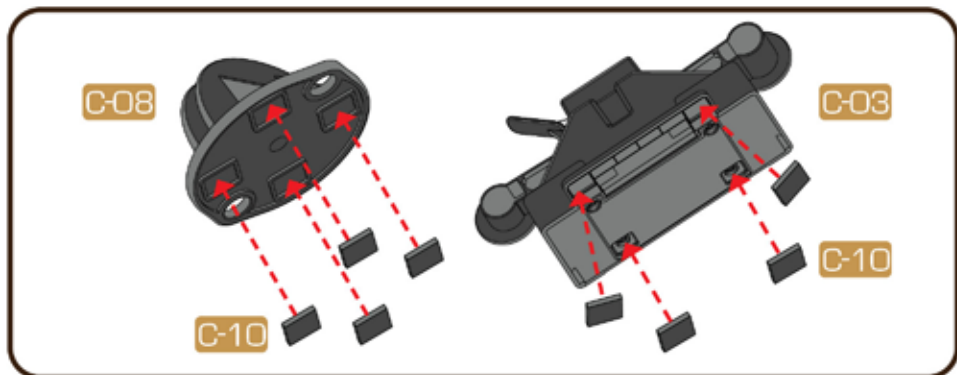

INITIAL ASSEMBLY

LABEL APPLICATION

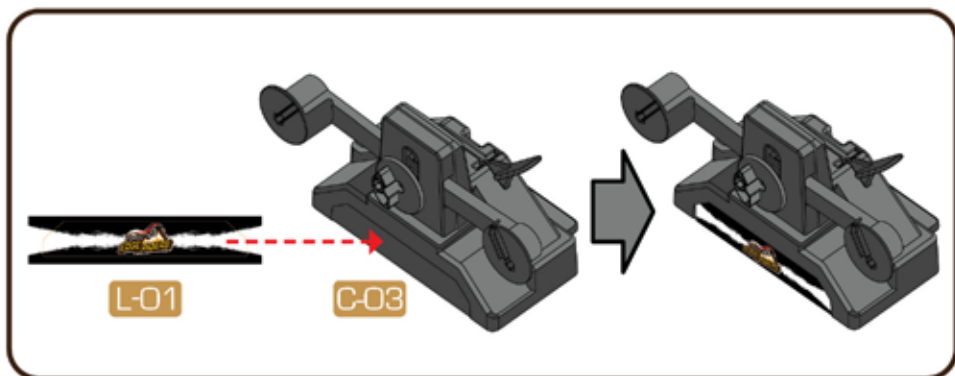

USING THE STANDS

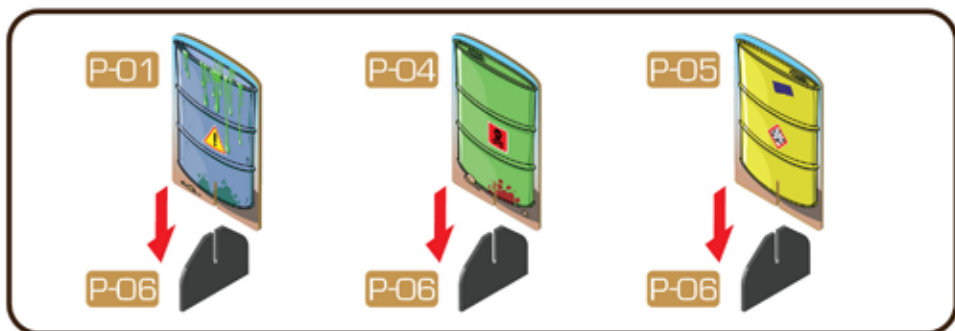

INITIAL ASSEMBLY

BUILDING THE CAR CRUSHER STUNT

1

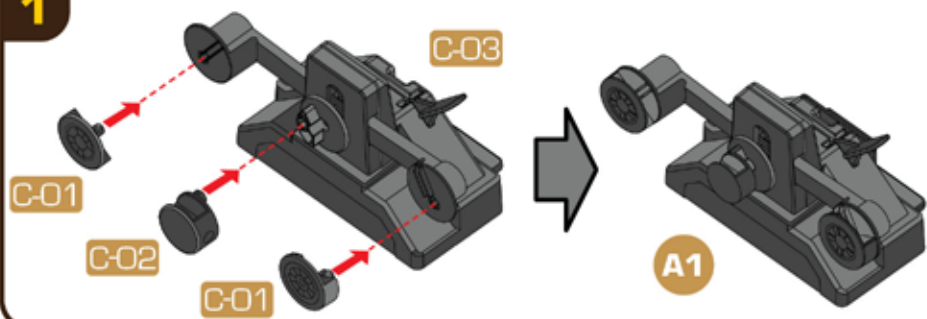

2

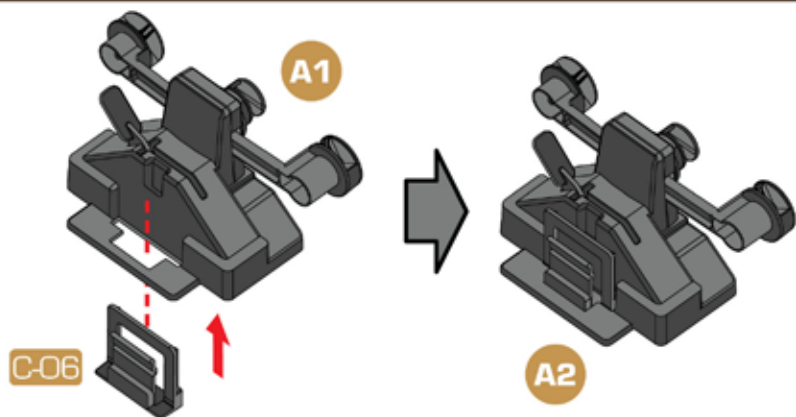

3

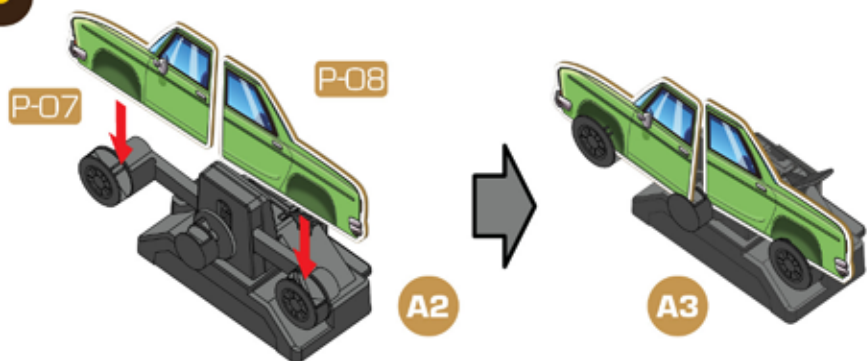

INITIAL ASSEMBLY

BUILDING SIGN SPLITTER STUNT

1

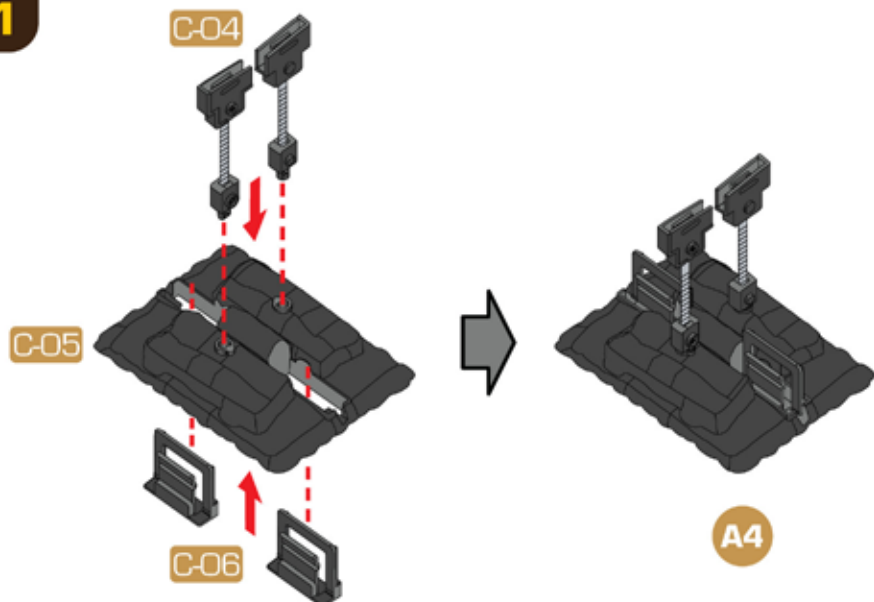

2

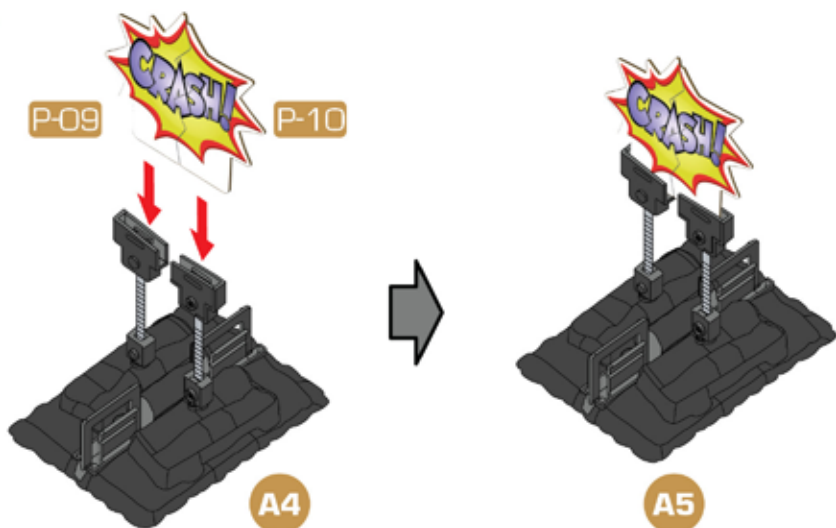

TRACK ASSEMBLY

BUILDING THE TRACK

1

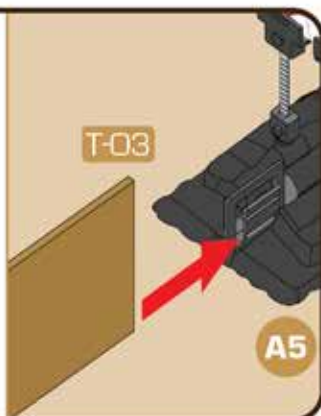

2

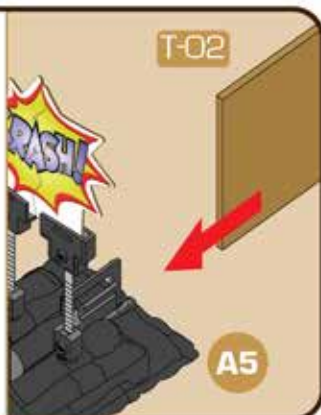

3

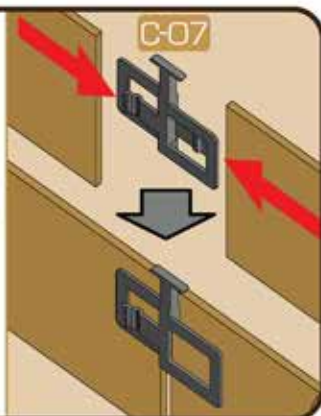

TRACK ASSEMBLY

BUILDING THE TRACK

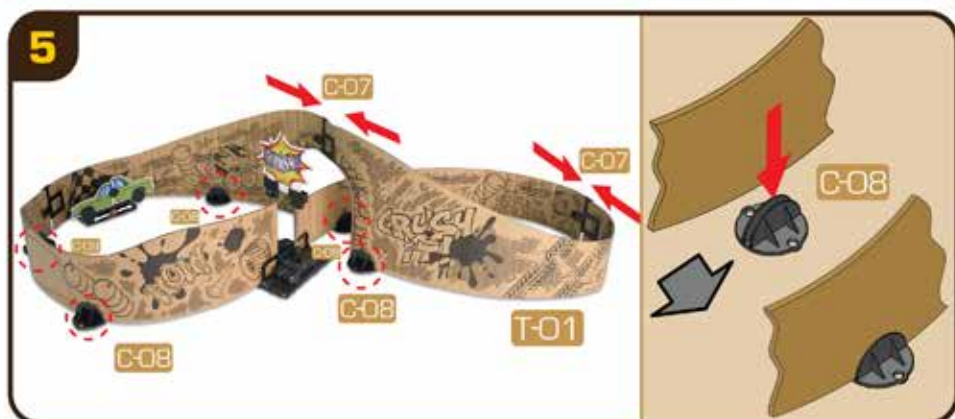

LET'S GO!

If necessary, add suction cups to one stand to make it stay on the floor firmly.

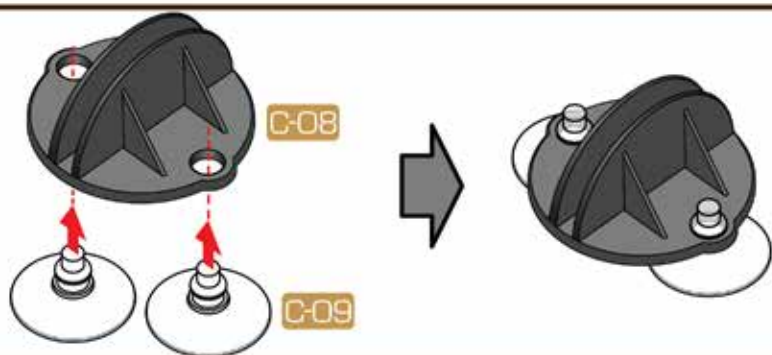

Switch the vehicle on and place it carefully on the track to start the rush.





Getting Started

Gather your DIY tools.



Warning: Adult supervision is required.

Recycle any spare cardboard with thickness of approximately 6-8mm to make new tracks.



Use the ruler to measure the height.



The heights should match!

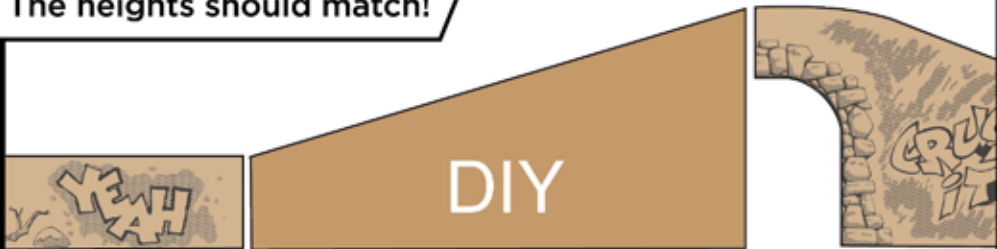



More Tracks, More Fun

Design some DIY track.

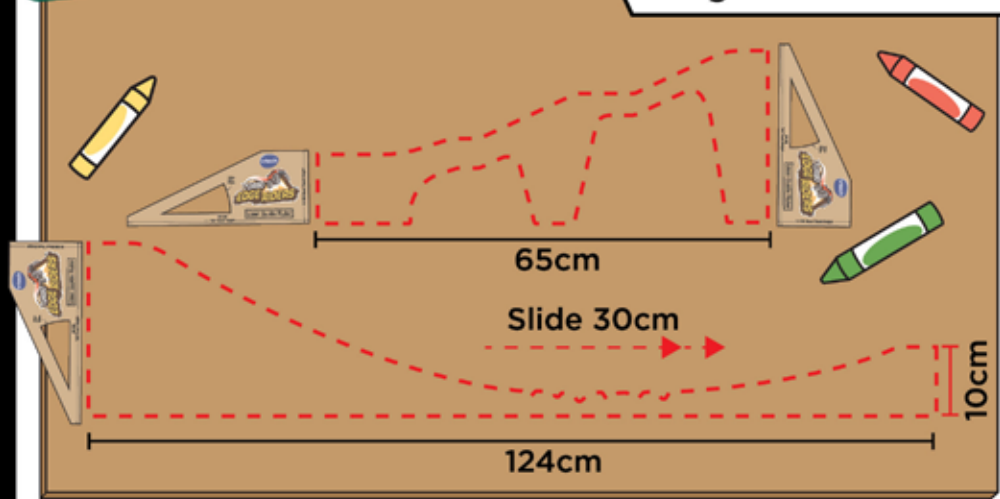

Use paper rolls and scrap paper to add some fun!

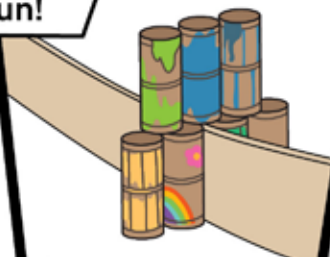

Join the tracks with connectors (C-07).

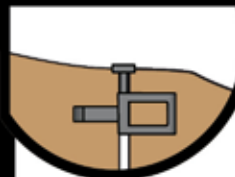

Use a stand (C-08) to stabilize.



DIY

Design Fun Accessories

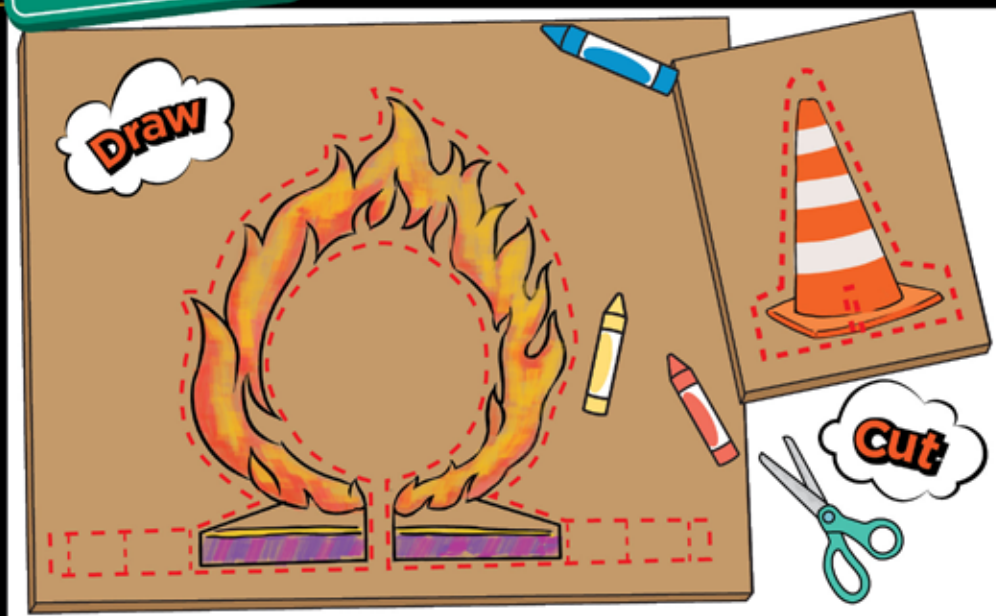

Don't forget the stand...



...or build the stand in.

Fold

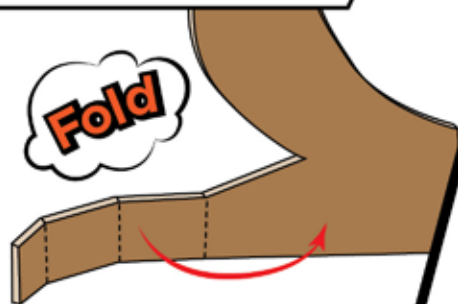

Tape or Glue

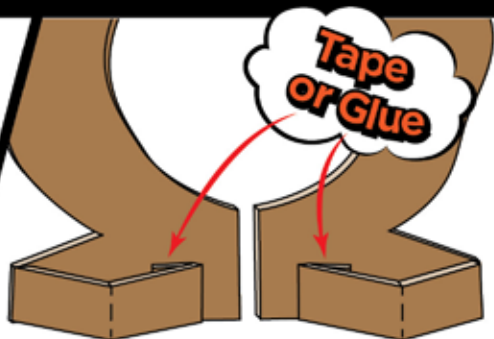

DIY

Design Your Own Crusher

Draw



Part A

Part B

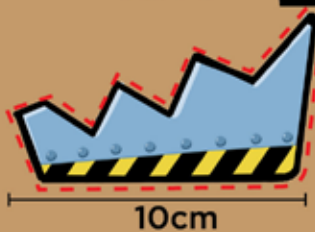
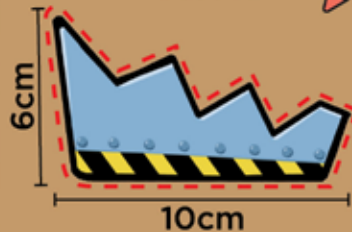

Cut

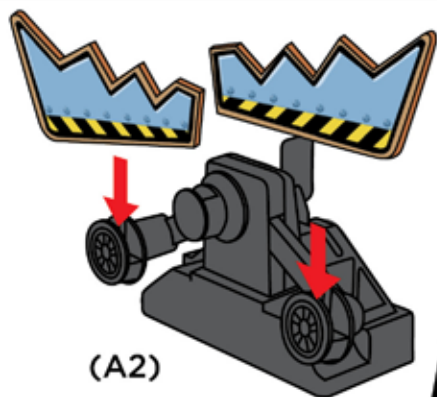

(A2)



BOOM!



Customize Your Crash

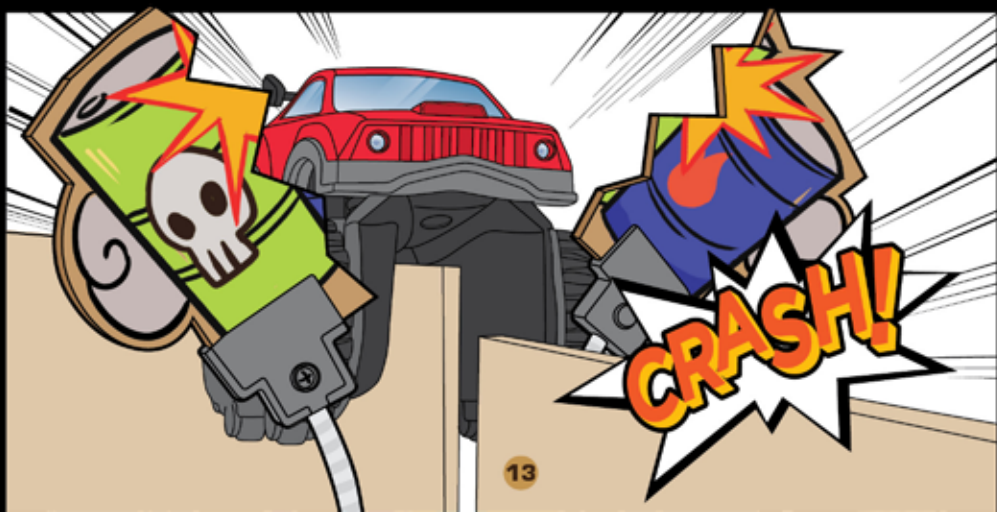
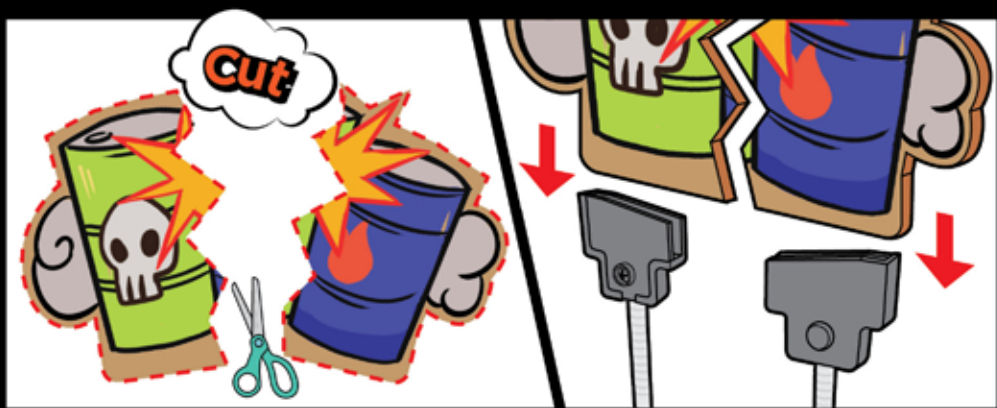

STEAM

Think Like an Engineer!

The Engineering Design Process is a way of thinking to solve problems.

What Engineers Do?

- Design
- Build
- Fix things

? Start with a question

Example

How can I make a paper airplane that flies across the room?



1 Plan & Design



There are no bad ideas in brainstorming.



Start by researching.



Write or sketch ideas.



Pick an idea to try.

Brainstorm

Throw plane harder

Try new folding method

Use thick paper

Change size of wings

Different colors of paper



Start to build

2 Build

Gather materials
& start creating!

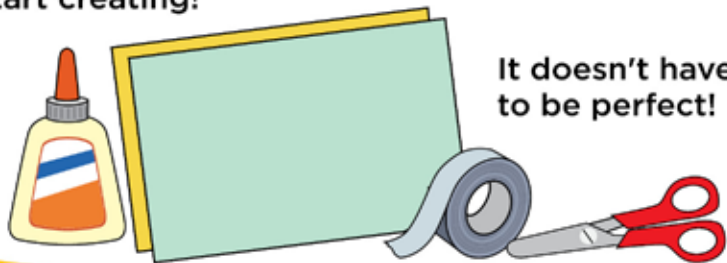

It doesn't have
to be perfect!

! Ask an adult for
help with safety.

3 Test



Gather testing tools.

- Test your solution a few times.
- Take notes as you go.
- Set up testing environment.
- Test your solution in different ways.

4 Reflect & Improve

Hmm.. my idea
didn't work.

I wonder why...

I have an idea to
improve it!
I'll try wider wings
next time.



- ? What went well?
- ? What could you do differently?
- Go back to the Plan and Design phase to make adjustments.
- Use what you learn on your next try.

Knowledge Pit Stop 1

- **Gravity** is the force that pulls objects to the Earth.
- When an object tries to go uphill, it must work harder to go against gravity.
- When an object goes downhill, it works with gravity.



Engineering Challenge

1

Start with a question



How does the speed of a car change driving uphill versus downhill?

*Uphill, downhill
Hmm.. I wonder
which path is faster?*



2 Plan and Design

Sketch out track pieces with slopes that go uphill and slopes that go downhill.

Try out slopes with different levels of steepness.

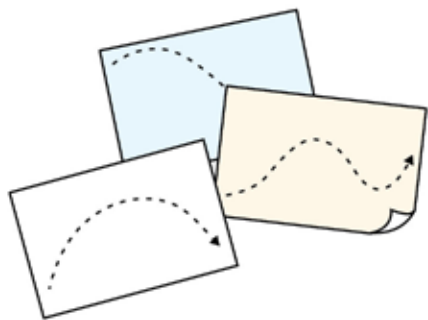

Pick an idea you'd like to try



3 Build

Step 1:
Draw your hill designs

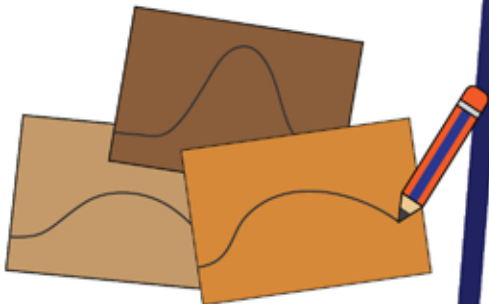

Step 2:
Cut your designs

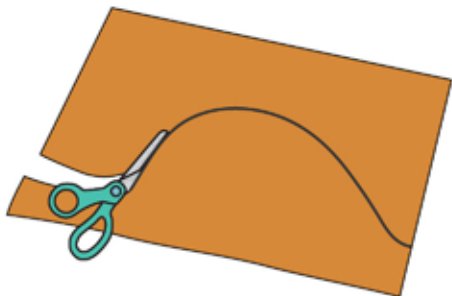

Step 3:

Make a copy

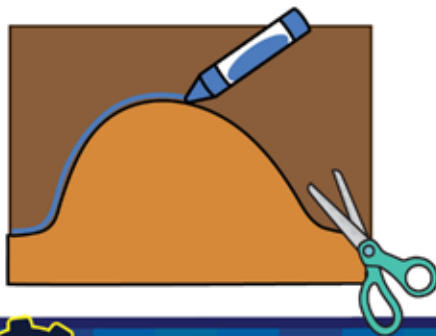
**Step 4:**

Assemble your track

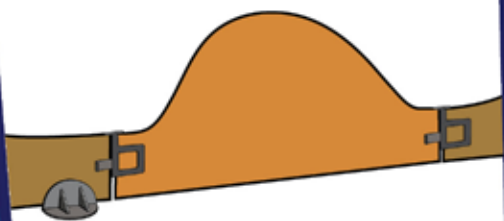
**4****Test**

Faster going uphill or downhill?



Hill A

Hill B

Hill C

Hill D

Rank the speed at the top or bottom of the slope you created from **1** (fastest) to **4** (slowest)

**5****Reflect**

- ? Is it faster for cars to go uphill or downhill?
- ? How does the steepness of the slope change the speed?
- ? Can you adjust the copy to make each hill too steep to climb?

Knowledge Pit Stop 2

- When an object is fast, it has more **momentum and force** when it runs into another object.
- The force of the car sets off the car crash stunt.
- The amount of force applied can change the car crash stunt effect.

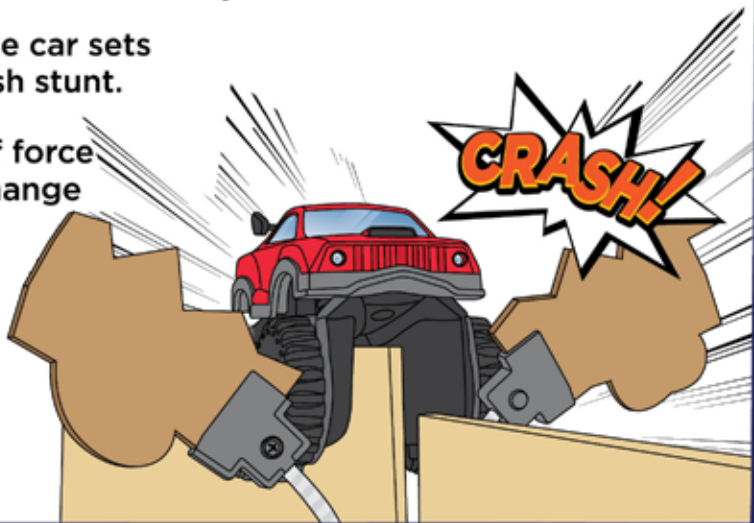

Engineering Challenge

1

Start with a question



How can we set off the perfect confetti surprise?

Confetti Surprise!
Woohoo!



2

Plan and Design

Design something to hold some confetti. Sketch out different designs to test.

What track design will make the car go faster?

Look back at [Challenge #1](#).

How can you store the confetti?

Try storing confetti on paper rolls

@ Page 10!



3

Build

Step 1:

Make your confetti by tearing paper

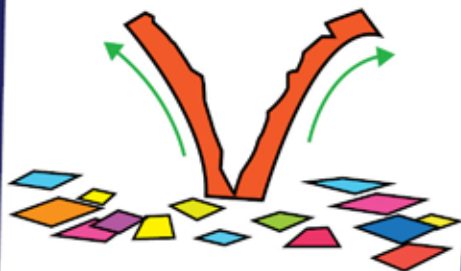

Step 2:

Find a way to hold the confetti



Step 3:

Build the track and place the confetti stunt where you want it



4 Test

Put the car on the track and test it out.

Adjust the track or the stunt if your confetti surprise isn't to your liking.



5 Reflect

- ? What changes did you make to create the perfect confetti surprise?
- ? What was challenging about getting the confetti surprise to work?
- ? What would you do differently next time?

Jr. Engineer

CERTIFICATE

Awarded to:



Date

Awarded by
